

Eclipse 6

72" x 42" x 22"

Silver Series \$1950 #ES7242	Gold Series \$2975 #EG7242	Platinum Series \$5350 #EP7242	Soaking Tub \$1195 #ETO7242
--	--------------------------------------	--	---------------------------------------

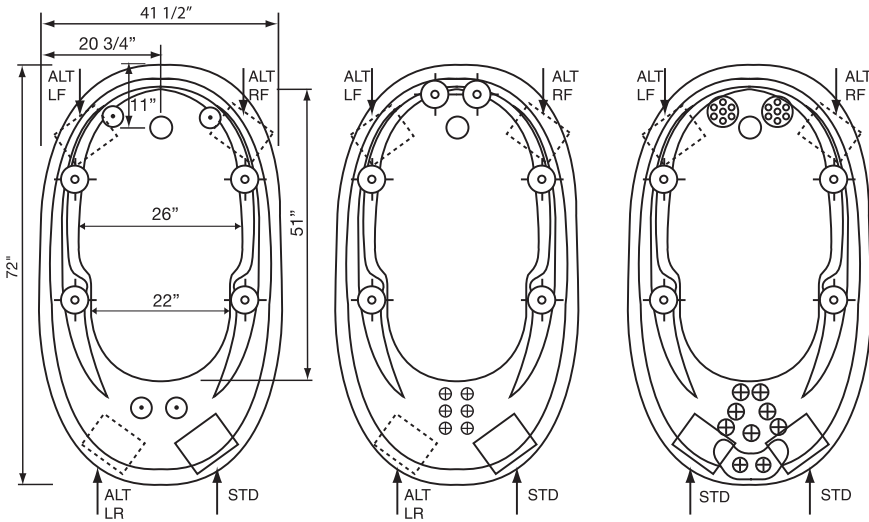

Equipment Legend

- Accu-Massage
- Micro Flow or Opt. Micromassage
- Ultra Flow or Optional Ultra Massage
- Sole Soother
- Neck Masseur Pillow
- Pump
- Alt. Pump
- Pump Access (18"x18" required)
*Some pump locations & plumbing may extend beyond perimeter of bath

Electrical Specifications

Pump Requirement

115V 15AMP w/GFCI
115V 20AMP w/GFCI

Inline Heater Requirement

115V 15AMP w/GFCI

	Silver	Gold	Platinum
Pump Requirement	1	1	2
Inline Heater Requirement	optional	1	1

Gallons to Overflow 90 gal
Gallons to Operate 75 gal

NOTE: Specifications are $\pm 1/4"$ and features are subject to change without notice
All final measurements should be taken from tub on site

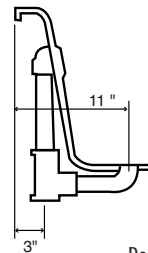

Rough In Plumbing Measurements

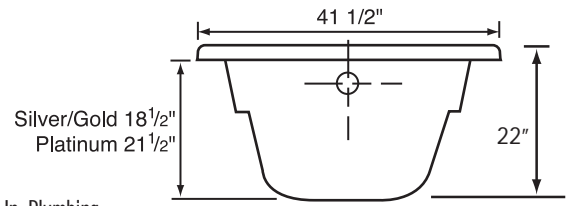

Features

	Silver Series	Gold Series	Platinum Series		Silver Series	Gold Series	Platinum Series
JETS				Aromatherapy Fragrance System	\$195	\$195	\$195
Total number of jets	8	12	15	Fragrance Refills	\$16.95	\$16.95	\$16.95
Accu-Massage	N/A	6	9	Hydrocleanse Whirlpool Sys Clnr	\$19.95	\$19.95	\$19.95
Micro Flow	4	N/A	N/A	GRAB BAR			
Micro Massage (each)	\$40	\$40	N/A	Bolt on PB, PC, SN, WH, ALM, BISC	\$125ea	\$125ea	2-Incl.
Ultra Flow	4	6	4	Standard Grab Bars will be color coordinated to match whirlpool			
Ultra Massage (each)	\$50	\$50	\$50	DRAIN KITS			
Sole Soother Seven (N/A in Metallic)	N/A	N/A	2	Lift N Turn PB, PC, SN, WH, ALM, BISC, ORB	\$95	Incl.	N/A
Back Masseur System	N/A	Incl.	Incl.	Deluxe Cable Drain PB, PC, SN, WH, ALM, BISC, ORB	\$250	\$250	Incl.
Neck Masseur Pillow (incl 2 jets)	N/A	\$450	Incl.	Standard drain colored to match whirlpool with ABS rough unless specified			otherwise
Metallic Trim Kit PC, PB, SN, ORB	\$250	\$350	\$400	LIGHTS			
PUMPS				Mood Light	\$195	\$195	Incl.
2.25 Hydro Power 1 speed	Incl.	N/A	N/A	Chromatherapy	\$395	\$395	\$395
2.25 Hydro Power 3 speed	\$250	N/A	2-Incl.	PILLOW			
3.25 Hydro Power 3 speed	N/A	Incl.	N/A	Deluxe Oval	\$80	Incl.	N/A
Alternate Pump Location*	Incl.	Incl.	Incl.	STANDARD COLORS			
Custom Pump Location(s)	\$180	\$180	\$180ea	White Bone Almond Biscuit	Incl.	Incl.	Incl.
HEATER				Design Colors-refer to page 5	\$495	\$495	\$495
Heater Inline/Electric	\$395	Incl.	Incl.	EZ LEVEL QUIET BASE	N/A	#300	N/A
Hydro Clean Sanitation System	\$495	\$495	\$495	Alters deck height. Contact factory.			
CONTROLS				EZ LEVEL BARS	\$150	\$150	N/A
Air Switch on/off	Incl.	Incl.	N/A	‡ Rush order 72 hour manufacturing (contact factory)	\$495	\$495	\$495
Air Switch with Digital Temp Readout	N/A	N/A	Incl.	Shipping Boxes	\$90	\$90	\$90

Eclipse 6

72" x 42" x 22"

Air Massage Series \$3275
#EA7242

Combination Series \$5750
#EC7242

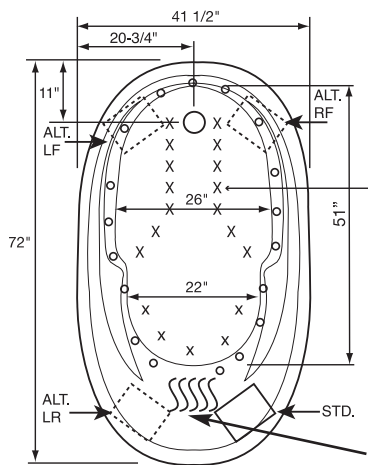

Optional
Deluxe in floor
Air Massage
jets—provide
muscle therapy
directly to the legs
and body.

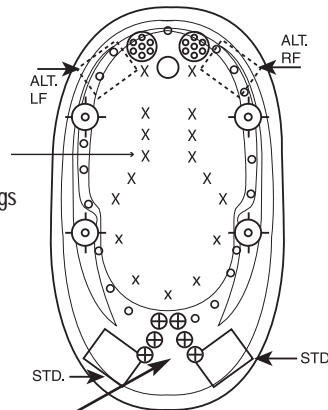

Standard
Warm Air FDA
Tubing Zone

Equipment Legend

- X Optional deluxe in floor air massage jets
 - Turbo Air Jet
 - ⊕ Accu-Massage
 - Micro Flow or Optional Micromassage
 - Ultra Flow or Optional Ultra Massage
 - ⊙ Sole Soother
 - ⊕ Neck Masseur Pillow
 - Pump
 - Alt. Pump
 - Heated FDA Tubing Zone
- Pump Access (18"x18" required)
*Some pump locations & plumbing may extend beyond perimeter of bath

Electrical Specifications

	Air Massage	Combination
Pump Requirement		
115V 15AMP w/GFCI	1	1
115V 20AMP w/GFCI		1
Inline Heater Requirement		
115V 15AMP w/GFCI		1
Gallons to Overflow	90 gal	
Gallons to Operate	75 gal	

NOTE: Specifications are ± 1/4" and features are subject to change without notice
All final measurements should be taken from tub on site

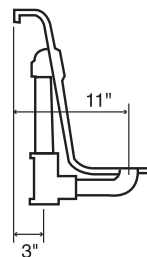

Rough In Plumbing
Measurements

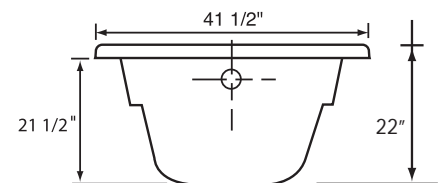

Features

	Air Massage Series	Combination Series	Air Massage Series	Combination Series
JETS				
Total number of jets	18	30		
Deluxe air systems	\$995	\$995		
Accu-Massage	N/A	6		
Micro Flow	N/A	N/A		
Micro Massage (each)	N/A	N/A		
Ultra Flow	N/A	4		
Ultra Massage (each)	N/A	\$50		
Sole Soother Seven (N/A in Metallic)	N/A	2 Incl.		
Back Masseur System	N/A	Incl.		
Neck Masseur Pillow (incl 2 jets)	N/A	\$450		
Metallic Trim Kit PC, PB, SN, ORB	\$350	\$600		
PUMPS				
1.25 AP variable speed	Incl.	Incl.		
3.25 Hydro Power 3 speed	N/A	Incl.		
Pump Location/Alternate*	Incl.	Incl.		
Custom Pump Locataion(s)	\$180	\$180		
HEATER				
Heater Inline/Electric	N/A	Incl.		
HydroClean Sanitation System	N/A	\$495		
CONTROLS				
Air Switch on/off water pump	N/A	Incl.		
Electronic variable speed	Incl.	Incl.		
AROMATHERAPY FRAGRANCE SYSTEM				
			\$195	\$195
Fragrance Refills			\$16.95	\$16.95
HYDROCLEANSE WHIRLPOOL SYS CLNER				
			\$19.95	\$19.95
GRAB BAR				
Bolt on PB, PC, SN, WH, ALM, BISC			\$125ea	2-Incl.
Standard Grab Bars will be color coordinated to match whirlpool				
DRAIN KITS				
Lift N Turn PC, PB, SN, WH, ALM, BISC, ORB			Incl.	N/A
Deluxe Cable Drain PB, PC, SN, WH, ALM, BISC, ORB			\$250	Incl.
Standard drain colored to match whirlpool with ABS rough unless specified otherwise				
LIGHTS				
Mood Light			\$195	Incl.
Chromatherapy			\$395	\$395
PILLOW				
Deluxe Oval			Incl.	Incl.
STANDARD COLORS				
White Bone Almond Biscuit			Incl.	Incl.
Special Colors-refer to page 5			\$495	\$495
EZ LEVEL QUIET BASE				
			Incl.	Incl.
‡ Rush order 72 hour manufacturing (contact factory)			\$495	\$495
Shipping Boxes			\$90	\$90