

Plat Combo #EPC6031RHSKTF/ #EPC6031LHSKTF	Gold Combo #EGC6031RHSKTF/ #EGC6031LHSKTF	Silver Combo #ESC6031RHSKTF/ #ESC6031LHSKTF	Air #EA6031RHSKTF/ #EA6031LHSKTF
\$7,300	\$5,650	\$4,200	\$3,295

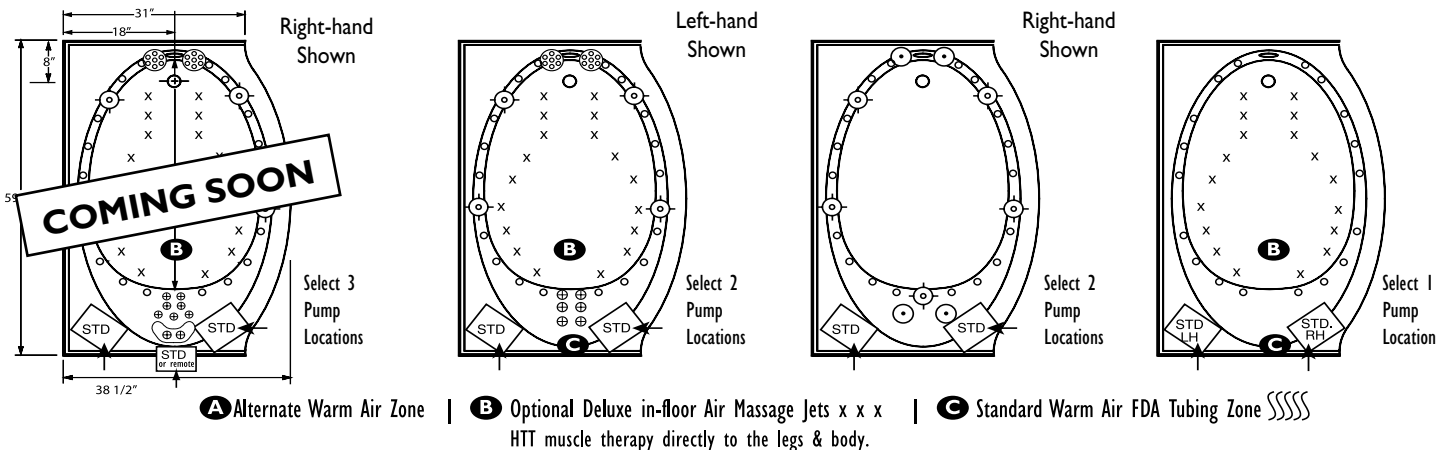

NOTE: Specifications are ± 1/4" and features are subject to change without notice. All final measurements should be taken from tub on site. *Some pump locations & plumbing may extend beyond perimeter of bath.

EQUIPMENT LEGEND											
	Air Massage Sidewall Jets	Optional Deluxe in-floor Air Massage Jets	Accu-Massage Jets	Micro Flow or Opt. Micromassage	Ultra Flow or Opt. Ultra Massage	Sole Soother	Neck Massage Pillow	Inlet/Outlet Port	Alt. Pump	Heated FDA Tubing Zone	Pump Access (18"x18" required)

ELECTRICAL SPECIFICATIONS	PLAT COMBO	GOLD COMBO	SILVER COMBO	AIR	PLAT	GOLD	SILVER	SOOTH SOAK
Dedicated Circuits Required								
PUMP REQ.								
115V 15AMP W/GFCI	3	2	2	1	2	1	1	1
INLINE HEATER REQ.								
115V 15AMP GFCI	1	1	OPT	-	1	1	OPT	-
WHISPER FLO HEAT SYSTEM™								
115V 15AMP GFCI	-	-	-	2	-	-	-	-

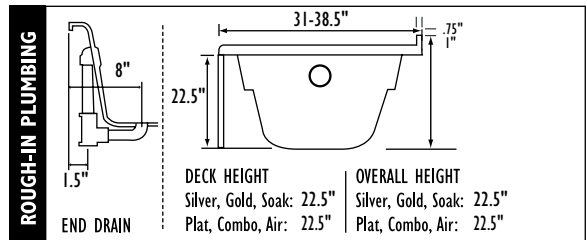

FEATURES	Plat Combo	Gold Combo	Silver Combo	Air
JETS — Total number of jets	33	30	21	18
Air Jets/Ports	18/108	18/108	12/72	18/108
Deluxe Air Jets In-Floor	\$995	\$995	N/A	\$995
Accu-Massage	9	6	N/A	N/A
Micro Flow	N/A	N/A	4	N/A
Micro Massage (each)	N/A	N/A	\$75	N/A
Ultra Flow	4	4	5	N/A
Ultra Massage (each)	\$95	\$95	\$95	N/A
Sole Soother™ 7 (N/A in Metallic)	2	2	N/A	N/A
Back Masseur System	Incl	Incl	N/A	N/A
Neck Masseur Pillow (incl 2 jets)	1-Incl	\$450	N/A	N/A
Metallic Trim Kit PC, PB, SN, ORB	\$750	\$600	\$550	\$350

PUMPS	Plat Combo	Gold Combo	Silver Combo	Air
1.0 Air Power 3 Speed	N/A	N/A	N/A	N/A
1.25 Air Power Variable Speed	Incl	Incl	Incl	Incl
2.25 Hydro Power 1 speed OR 3 speed	2-Incl N/A	N/A	1-Incl N/A	N/A
3.25 Hydro Power 3 speed	N/A	Incl	\$350	N/A
Whisper Flo™ Heat Pump	N/A	N/A	N/A	N/A
Alternate Pump Location	Incl	Incl	Incl	Incl
Custom Pump Location(s)	\$180	\$180	\$180	\$180

HEATER	Plat Combo	Gold Combo	Silver Combo	Air
Heater Inline/Electric	Incl	Incl	\$395	N/A
Whisper Flo™ Heat System	N/A	N/A	N/A	\$795

CONTROLS	Plat Combo	Gold Combo	Silver Combo	Air
Air Switch on/off	Incl	Incl	Incl	N/A
Air Switch w/ Digital Temp Readout	Incl	N/A	N/A	N/A
Electronic	Incl	Incl	N/A	Incl

HYDRO SCENTS™	Plat Combo	Gold Combo	Silver Combo	Air
Incl	\$195	\$195	\$195	\$195
Fragrance Refills	\$16.95	\$16.95	\$16.95	\$16.95
HYDRO CLEANSE™	\$19.95	\$19.95	\$19.95	\$19.95

FEATURES	Plat Combo	Gold Combo	Silver Combo	Air
HYDRO CLEAN™	Incl	Incl	Incl	\$495
HYDRO SOUNDS™	\$1,950.00	\$1,950.00	\$1,950.00	\$1,950.00

GRAB BAR(S)	Plat Combo	Gold Combo	Silver Combo	Air
Bolt on PB, PC, SN, WH, ALM, BISC	2-Incl	2-Incl	\$125ea	\$125ea
Standard Grab Bars will be color coordinated to match whirlpool				

TILE FLANGE	Plat Combo	Gold Combo	Silver Combo	Air
	Incl	Incl	Incl	Incl

DRAIN KITS	Plat Combo	Gold Combo	Silver Combo	Air
Lift N Turn PB, PC, SN, WH, ALM, BISC, ORB	N/A	N/A	Incl	Incl
Deluxe Cable Drain PB, PC, SN, WH, ALM, BISC, ORB Standard color coordination & PVC rough	Incl	Incl	\$250	\$250

LIGHTS	Plat Combo	Gold Combo	Silver Combo	Air
Mood Light	N/A	N/A	Incl	Incl
Chromatherapy	Incl	Incl	\$395	\$395

PILLOW	Plat Combo	Gold Combo	Silver Combo	Air
Deluxe Oval	N/A	Incl	Incl	Incl

STANDARD COLORS	Plat Combo	Gold Combo	Silver Combo	Air
White, Bone, Almond & Biscuit	Incl	Incl	Incl	Incl
Design Colors—refer to page 8	\$495	\$495	\$495	\$495

EZ LEVEL QUIET BASE™	Plat Combo	Gold Combo	Silver Combo	Air
	Incl	Incl	\$350*	Incl
*Use Plat, Combo, Air Deck Heights				

EZ LEVEL BARS	Plat Combo	Gold Combo	Silver Combo	Air
	N/A	N/A	\$150*	N/A
*Use Plat, Combo, Air Deck Heights				
Rush Order 72hr Manufacturing (confirm with factory)	\$495	\$495	\$495	\$495
Shipping Boxes	\$90	\$90	\$90	\$90

Plat #EP6031RHSKTF/ #EP6031LHSKTF	Gold #EG6031RHSKTF/ #EG6031LHSKTF	Silver #ES6031RHSKTF/ #ES6031LHSKTF	Sooth Soak #ESS6031RHSKTF/ #ESS6031LHSKTF	Soaking #ETO6031RHSKTF/ #ETO6031LHSKTF
\$5,350	\$2,995	\$2,350	\$2,695	\$1,295

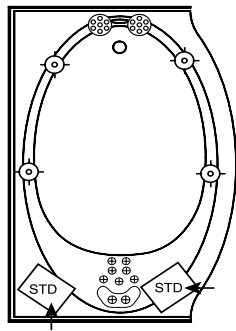

Select 2 Pump Locations

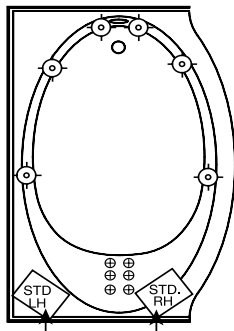

Select 1 Pump Location

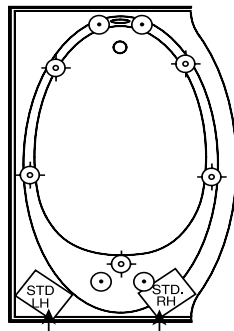

Select 1 Pump Location

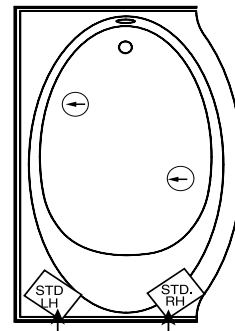

Select 1 Pump Location

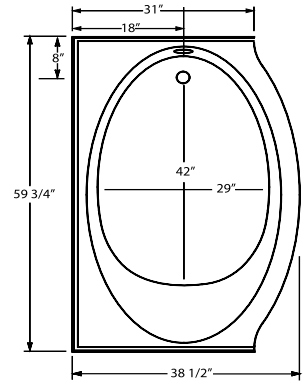

NOTE: Specifications are ± 1/4" and features are subject to change without notice. All final measurements should be taken from tub on site. *Some pump locations & plumbing may extend beyond perimeter of bath.

EQUIPMENT LEGEND											
	Air Massage Sidewall Jets	Optional Deluxe in-floor Air Massage Jets	Accu-Massage Jets	Micro Flow or Opt. Micromassage	Ultra Flow or Opt. Ultra Massage	Sole Soother	Neck Massage Pillow	Inlet/Outlet Port	Pump	Heated FDA Tubing Zone	Pump Access (18"x18" required)

ELECTRICAL SPECIFICATIONS Dedicated Circuits Required	PLAT COMBO	GOLD COMBO	SILVER COMBO	AIR	PLAT	GOLD	SILVER	SOOTH SOAK
PUMP REQ. 115V 15AMP W/GFCI	3	2	2	1	2	1	1	1
INLINE HEATER REQ. 115V 15AMP GFCI	1	1	OPT	-	1	1	OPT	-
WHISPER FLO HEAT SYSTEM™ 115V 15AMP GFCI	-	-	-	2	-	-	-	-

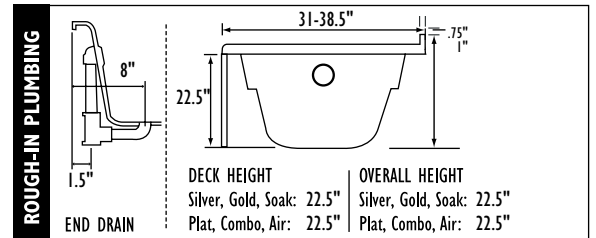

FEATURES	Plat	Gold	Silver/Bronze	Sooth Soak
JETS — Total number of jets	15	12	9	N/A
Air Jets/Ports	N/A	N/A	N/A	N/A
Deluxe Air Jets In-Floor	N/A	N/A	N/A	N/A
Accu-Massage	9	6	N/A	N/A
Micro Flow	N/A	N/A	4	N/A
Micro Massage (each)	N/A	N/A	\$75	N/A
Ultra Flow	4	6	5	N/A
Ultra Massage (each)	\$95	\$95	\$95	N/A
Sole Soother™ 7 (N/A in Metallic)	2	N/A	N/A	N/A
Back Masseur System	Incl	Incl	N/A	N/A
Neck Masseur Pillow (incl 2 jets)	1-Incl	\$450	N/A	\$450
Metallic Trim Kit PC, PB, SN, ORB	\$400	\$350	\$250	N/A

PUMPS	Plat	Gold	Silver/Bronze	Sooth Soak
1.0 Air Power 3 Speed	N/A	N/A	N/A	N/A
1.25 Air Power Variable Speed	N/A	N/A	N/A	N/A
2.25 Hydro Power 1 speed OR 3 speed	N/A 2-Incl	N/A N/A	Incl N/A	N/A N/A
3.25 Hydro Power 3 speed	N/A	Incl	\$350	N/A
Whisper Flo™ Heat Pump	N/A	N/A	N/A	Incl
Alternate Pump Location	Incl	Incl	Incl	Incl
Custom Pump Location(s)	\$180	\$180	\$180	\$180

HEATER	Plat	Gold	Silver/Bronze	Sooth Soak
Heater Inline/Electric	Incl	Incl	\$395	N/A
Whisper Flo™ Heat System	N/A	N/A	N/A	N/A

CONTROLS	Plat	Gold	Silver/Bronze	Sooth Soak
Air Switch on/off	Incl	Incl	Incl	Incl
Air Switch w/ Digital Temp Readout	Incl	N/A	N/A	N/A
Electronic	N/A	N/A	N/A	N/A

HYDRO SCENTS™	Plat	Gold	Silver/Bronze	Sooth Soak
Fragrance Refills	\$195	\$195	\$195	N/A
HYDRO CLEANSE™	\$19.95	\$19.95	\$19.95	\$19.95

FEATURES	Plat	Gold	Silver/Bronze	Sooth Soak
HYDRO CLEAN™	Incl	\$495	\$495	\$495
HYDRO SOUNDS™	\$1,950.00	\$1,950.00	\$1,950.00	\$1,950.00

GRAB BAR(S)	Plat	Gold	Silver/Bronze	Sooth Soak
Bolt on PB, PC, SN, WH, ALM, BISC	2-Incl	\$125ea	\$125ea	\$125ea
Standard Grab Bars will be color coordinated to match whirlpool				

TILE FLANGE	Plat	Gold	Silver/Bronze	Sooth Soak
	Incl	Incl	Incl	Incl

DRAIN KITS	Plat	Gold	Silver/Bronze	Sooth Soak
Lift N Turn PB, PC, SN, WH, ALM, BISC, ORB	N/A	Incl	\$95	Incl
Deluxe Cable Drain PB, PC, SN, WH, ALM, BISC, ORB Standard color coordination & PVC rough	Incl	\$250	\$250	\$250

LIGHTS	Plat	Gold	Silver/Bronze	Sooth Soak
Mood Light	N/A	Incl	\$195	N/A
Chromatherapy	Incl	\$395	\$395	Incl

PILLOW	Plat	Gold	Silver/Bronze	Sooth Soak
Deluxe Oval	N/A	Incl	\$80	Incl

STANDARD COLORS	Plat	Gold	Silver/Bronze	Sooth Soak
White, Bone, Almond & Biscuit	Incl	Incl	Incl	Incl
Design Colors—refer to page 8	\$495	\$495	\$495	\$495

EZ LEVEL QUIET BASE™	Plat	Gold	Silver/Bronze	Sooth Soak
	Incl	N/A	N/A	\$350*
*Use Plat, Combo, Air Deck Heights				

EZ LEVEL BARS	Plat	Gold	Silver/Bronze	Sooth Soak
	N/A	\$150*	\$150*	\$150*
*Use Plat, Combo, Air Deck Heights				
Rush Order 72hr Manufacturing (confirm with factory)	\$495	\$495	\$495	\$495
Shipping Boxes	\$90	\$90	\$90	\$90