

<b>Plat Combo #HPC7236</b>	<b>Gold Combo #HGC7236</b>	<b>Silver Combo #HSC7236</b>	<b>Air #HA7236</b>
<b>\$7,300</b>	<b>\$5,650</b>	<b>\$4,000</b>	<b>\$3,495</b>

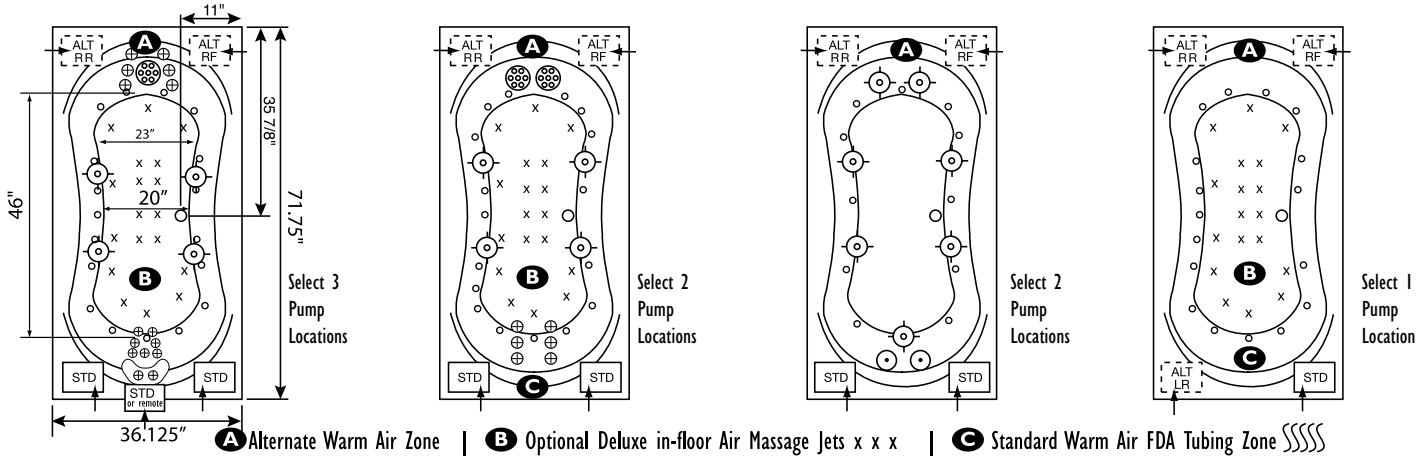

**NOTE:** Specifications are ± 1/4" and features are subject to change without notice. All final measurements should be taken from tub on site. \*Some pump locations & plumbing may extend beyond perimeter of bath.

EQUIPMENT LEGEND											
	Air Massage Sidewall Jets	Optional Deluxe in-floor Air Massage Jets	Accu-Massage Jets	Micro Flow or Opt. Micromassage	Ultra Flow or Opt. Ultra Massage	Sole Soother	Neck Massage Pillow	Inlet/Outlet Port	Pump	Heated FDA Tubing Zone	Pump Access (18"x18" required)

ELECTRICAL SPECIFICATIONS Dedicated Circuits Required	PLAT COMBO	GOLD COMBO	SILVER COMBO	AIR	PLAT	GOLD	SILVER	SOOTH SOAK
<b>PUMP REQ.</b> 115V 15AMP W/GFCI	3	2	2	1	2	1	1	1
<b>INLINE HEATER REQ.</b> 115V 15AMP GFCI	1	1	OPT	-	1	1	OPT	-
<b>WHISPER FLO HEAT SYSTEM™</b> 115V 15AMP GFCI	-	-	-	2	-	-	-	-

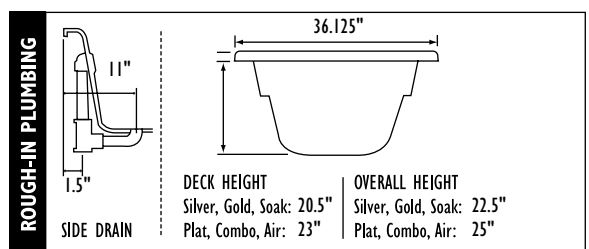

FEATURES	Plat Combo	Gold Combo	Silver Combo	Air
<b>JETS</b> — Total number of jets	38	30	21	18/108
Air Jets/Ports	18/108	18/108	12/72	18/108
Deluxe Air Jets In-Floor	\$995	\$995	N/A	\$995
Accu-Massage	15	6	N/A	N/A
Micro Flow	N/A	N/A	4	N/A
Micro Massage (each)	N/A	N/A	\$75	N/A
Ultra Flow	4	4	5	N/A
Ultra Massage (each)	\$95	\$95	\$95	N/A
Sole Soother™ 7 (N/A in Metallic)	1	2	N/A	N/A
Back Masseur System	Incl	Incl	N/A	N/A
Neck Masseur Pillow (incl 2 jets)	1-Incl	\$450	N/A	N/A
Metallic Trim Kit PC, PB, SN, ORB	\$750	\$600	\$550	\$350

PUMPS	Plat Combo	Gold Combo	Silver Combo	Air
1.0 Air Power 3 Speed	N/A	N/A	Incl	N/A
1.25 Air Power Variable Speed	Incl	Incl	N/A	Incl
2.25 Hydro Power 1 speed	N/A	N/A	Incl	N/A
3.25 Hydro Power 3 speed	2-Incl	Incl	\$350	N/A
Whisper Flo™ Heat Pump	N/A	N/A	N/A	N/A
Alternate Pump Location	Incl	Incl	Incl	Incl
Custom Pump Location(s)	\$180	\$180	\$180	\$180

HEATER	Plat Combo	Gold Combo	Silver Combo	Air
Heater Inline/Electric	Incl	Incl	\$395	N/A
Whisper Flo™ Heat System	N/A	N/A	N/A	\$795

CONTROLS	Plat Combo	Gold Combo	Silver Combo	Air
Air Switch on/off	Incl	Incl	Incl	N/A
Air Switch w/ Digital Temp Readout	Incl	N/A	N/A	N/A
Electronic	Incl	Incl	N/A	Incl

HYDRO SCENTS™	Plat Combo	Gold Combo	Silver Combo	Air
Incl	\$195	\$195	\$195	\$195
Fragrance Refills	\$16.95	\$16.95	\$16.95	\$16.95
<b>HYDRO CLEANSE™</b>	\$19.95	\$19.95	\$19.95	\$19.95

FEATURES	Plat Combo	Gold Combo	Silver Combo	Air
<b>HYDRO CLEAN™</b>	Incl	Incl	Incl	\$495

HYDRO SOUNDS™	Plat Combo	Gold Combo	Silver Combo	Air
	\$1,950.00	\$1,950.00	\$1,950.00	\$1,950.00

GRAB BAR(S)	Plat Combo	Gold Combo	Silver Combo	Air
Bolt on PB, PC, SN, WH, ALM, BISC	N/A	N/A	N/A	N/A
Standard Grab Bars will be color coordinated to match whirlpool				

TILE FLANGE	Plat Combo	Gold Combo	Silver Combo	Air
	N/A	N/A	N/A	N/A

DRAIN KITS	Plat Combo	Gold Combo	Silver Combo	Air
Lift N Turn PB, PC, SN, WH, ALM, BISC, ORB	N/A	N/A	Incl	Incl
Deluxe Cable Drain PB, PC, SN, WH, ALM, BISC, ORB Standard color coordination & PVC rough	Incl	Incl	\$250	\$250

LIGHTS	Plat Combo	Gold Combo	Silver Combo	Air
Mood Light	N/A	N/A	Incl	Incl
Chromatherapy	Incl	Incl	\$395	\$395

PILLOW	Plat Combo	Gold Combo	Silver Combo	Air
Deluxe Oval	Incl	Incl	Incl	Incl

STANDARD COLORS	Plat Combo	Gold Combo	Silver Combo	Air
White, Bone, Almond & Biscuit	Incl	Incl	Incl	Incl
Design Colors—refer to page 8	\$495	\$495	\$495	\$495

EZ LEVEL QUIET BASE™	Plat Combo	Gold Combo	Silver Combo	Air
	Incl	Incl	\$350*	Incl
*Use Plat, Combo, Air Deck Heights				

EZ LEVEL BARS	Plat Combo	Gold Combo	Silver Combo	Air
	N/A	N/A	\$150*	N/A
*Use Plat, Combo, Air Deck Heights				
Rush Order 72hr Manufacturing	\$495	\$495	\$495	\$495
(confirm with factory)				
Shipping Boxes	\$90	\$90	\$90	\$90

Plat #HP7236	Gold #HG7236	Silver #HS7236	Sooth Soak #HSS7236	Soaking #HTO7236
\$5,350	\$2,995	\$2,150	\$2,795	\$1,395

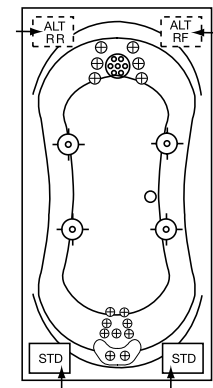

Select 2 Pump Locations

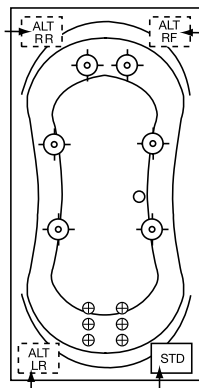

Select 1 Pump Location

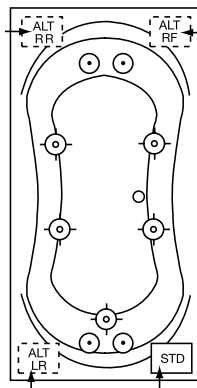

Select 1 Pump Location

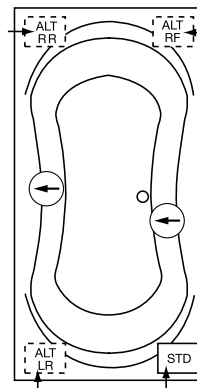

Select 1 Pump Location

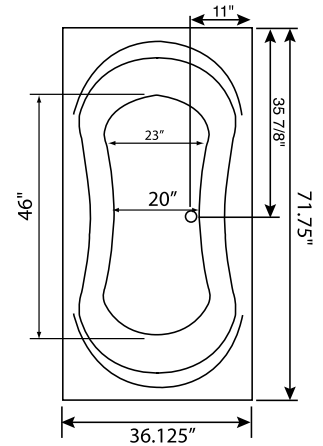

**NOTE:** Specifications are ± 1/4" and features are subject to change without notice. All final measurements should be taken from tub on site. \*Some pump locations & plumbing may extend beyond perimeter of bath.

EQUIPMENT LEGEND											
	Air Massage Sidewall Jets	Optional Deluxe in-floor Air Massage Jets	Accu-Massage Jets	Micro Flow or Opt. Micromassage	Ultra Flow or Opt. Ultra Massage	Sole Soother	Neck Massage Pillow	Inlet/Outlet Port	Pump	Heated FDA Tubing Zone	Pump Access (18"x18" required)

ELECTRICAL SPECIFICATIONS Dedicated Circuits Required	PLAT COMBO	GOLD COMBO	SILVER COMBO	AIR	PLAT	GOLD	SILVER	SOOTH SOAK
<b>PUMP REQ.</b> 115V 15AMP W/GFCI	3	2	2	1	2	1	1	1
<b>INLINE HEATER REQ.</b> 115V 15AMP GFCI	1	1	OPT	-	1	1	OPT	-
<b>WHISPER FLO HEAT SYSTEM™</b> 115V 15AMP GFCI	-	-	-	2	-	-	-	-

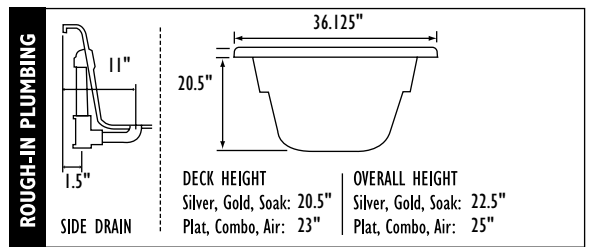

FEATURES	Plat	Gold	Silver	Sooth Soak
<b>JETS</b> — Total number of jets	20	12	9	N/A
Air Jets/Ports	N/A	N/A	N/A	N/A
Deluxe Air Jets In-Floor	N/A	N/A	N/A	N/A
Accu-Massage	15	6	N/A	N/A
Micro Flow	N/A	N/A	4	N/A
Micro Massage (each)	N/A	N/A	\$75	N/A
Ultra Flow	4	6	5	N/A
Ultra Massage (each)	\$95	\$95	\$95	N/A
Sole Soother 7™ (N/A in Metallic)	1	N/A	N/A	N/A
Back Masseur System	Incl	Incl	N/A	N/A
Neck Masseur Pillow (incl 2 jets)	1-Incl	\$450	N/A	\$450
Metallic Trim Kit PC, PB, SN, ORB	\$400	\$350	\$250	N/A

PUMPS	Plat	Gold	Silver	Sooth Soak
1.0 Air Power 3 Speed	N/A	N/A	N/A	N/A
1.25 Air Power Variable Speed Air	N/A	N/A	N/A	Incl
2.25 Hydro Power 1 speed	N/A	N/A	Incl	N/A
3.25 Hydro Power 3 speed	2-Incl	Incl	\$350	N/A
Whisper Flo™ Heat Pump	N/A	N/A	N/A	Incl
Alternate Pump Location	Incl	Incl	Incl	Incl
Custom Pump Location(s)	\$180	\$180	\$180	\$180

HEATER	Plat	Gold	Silver	Sooth Soak
Heater Inline/Electric	Incl	Incl	\$395	N/A
Whisper Flo™ Heat System	N/A	N/A	N/A	N/A

CONTROLS	Plat	Gold	Silver	Sooth Soak
Air Switch on/off	N/A	Incl	Incl	Incl
Air Switch w/ Digital Temp Readout	Incl	N/A	N/A	N/A
Electronic	N/A	N/A	N/A	N/A

HYDRO SCENTS™	Plat	Gold	Silver	Sooth Soak
Fragrance Refills	\$16.95	\$16.95	\$16.95	N/A
<b>HYDRO CLEANSE™</b>	\$19.95	\$19.95	\$19.95	\$19.95

FEATURES	Plat	Gold	Silver	Sooth Soak
<b>HYDRO CLEAN™</b>	Incl	\$495	\$495	\$495

<b>HYDRO SOUNDS™</b>	\$1,950.00	\$1,950.00	\$1,950.00	\$1,950.00
----------------------	------------	------------	------------	------------

GRAB BAR(S)	Plat	Gold	Silver	Sooth Soak
Bolt on PB, PC, SN, WH, ALM, BISC	N/A	N/A	N/A	N/A
Standard Grab Bars will be color coordinated to match whirlpool				

<b>TILE FLANGE</b>	N/A	N/A	N/A	N/A
--------------------	-----	-----	-----	-----

DRAIN KITS	Plat	Gold	Silver	Sooth Soak
Lift N Turn PB, PC, SN, WH, ALM, BISC, ORB	N/A	Incl	\$95	Incl
Deluxe Cable Drain PB, PC, SN, WH, ALM, BISC, ORB Standard color coordination & PVC rough	Incl	\$250	\$250	\$250

LIGHTS	Plat	Gold	Silver	Sooth Soak
Mood Light	N/A	Incl	\$195	N/A
Chromatherapy	Incl	\$395	\$395	Incl

PILLOW	Plat	Gold	Silver	Sooth Soak
Deluxe Oval	Incl	Incl	\$80	Incl

STANDARD COLORS	Plat	Gold	Silver	Sooth Soak
White, Bone, Almond & Biscuit	Incl	Incl	Incl	Incl
Design Colors—refer to page 8	\$495	\$495	\$495	\$495

<b>EZ LEVEL QUIET BASE™</b>	Incl	N/A	N/A	\$350*
*Use Plat, Combo, Air Deck Heights				

EZ LEVEL BARS	Plat	Gold	Silver	Sooth Soak
*Use Plat, Combo, Air Deck Heights	N/A	\$150*	\$150*	\$150*
Rush Order 72hr Manufacturing (confirm with factory)	\$495	\$495	\$495	\$495
Shipping Boxes	\$90	\$90	\$90	\$90