

Tranquil 430

51" x 29" x 40"

Silver Series \$11,875 #TS 5030 /RH (right hand) #TS 5030/LH (left hand)	Gold Series \$12,825 #TG 5030/RH (right hand) #TG 5030/LH (left hand)	Soaking Tub \$10,900 #TTO 5030/RH (right hand) #TTO 5030/LH (left hand)
---	--	--

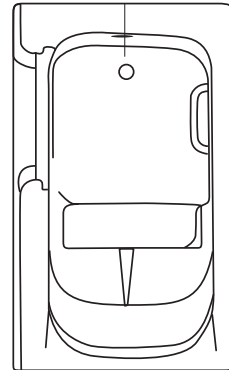
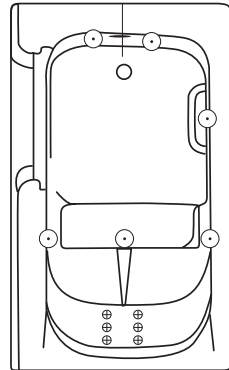
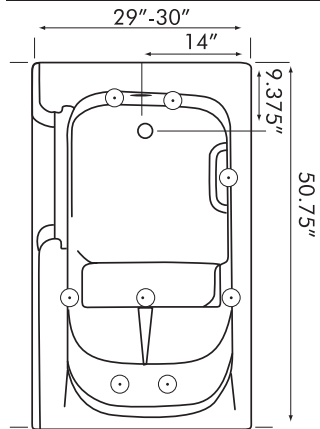

Equipment Legend

- ⊕ Micro Flow or Opt. Micromassage
- Ultra Flow or Opt. Ultra Massage
- ⊙ Sole Soother
- ⊕⊕ Neck Masseur Pillow
- Pump □ Alt. Pump
- ➔ Pump Access (18"x18" required)
*Some pump locations & plumbing may extend beyond perimeter of bath
- × Air Massage Deluxe Air Jet (optional)
- Turbo Air Jet

Electrical Specifications

	Silver	Gold
Pump Requirement		
115V 15AMP w/GFCI	1	
115 V 20 AMP w/GFCI		1
Inline Heater Requirement		
115V 15AMP w/GFCI	optional	1
Gallons to Operate with 170lbs bather	76	

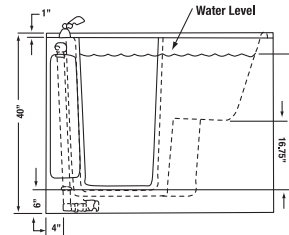
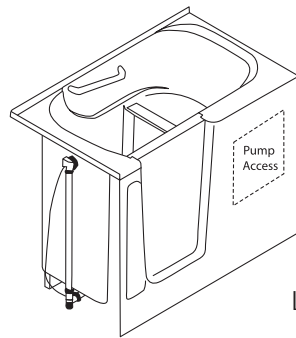

Left hand model shown

NOTE: Specifications are ± 1/4" and features are subject to change without notice. All final measurements should be taken from tub on site.

Features

	Silver Series	Gold Series		Silver Series	Gold Series
JETS			Deck Extension needed to convert to 60" framing pocket	\$460	\$460
Total number of jets	8	12	Faucet with Hand Shower	\$695	\$695
Accu-Massage	N/A	6	Thermostic Faucet, Valve, Hand Shower	\$1566	\$1566
Micro Flow	8	N/A	Wall Surround 3 Panel	\$1566	\$1566
Micro Massage (each)	\$40	\$40	Wall Surround 2 Panel	\$1225	\$1225
Sole Soother Seven (N/A in Metallic)	N/A	N/A	Curtain Rod w/ J hook and Ceiling Support	\$395	\$395
Back Masseur System	N/A	Incl.	Curtain Weighted White 78"x48"	\$200	\$200
Neck Masseur Pillow (incl 2 jets)	N/A	N/A	Aromatherapy Fragrance System	\$195	\$195
Metallic Trim Kit PC, PB, SN, ORB	\$250	\$350	Fragrance Refills	\$16.95	\$16.95
			Hydrocleanse Whirlpool Sys Clnr	\$19.95	\$19.95
PUMPS			GRAB BAR		
2.25 Hydro Power 1 speed	Incl.	N/A	Bolt on PC	Incl.	Incl.
2.25 Hydro Power 3 speed	\$250	N/A	TILE FLANGE		
3.25 Hydro Power 3 speed	N/A	incl.	2 Wall	Incl.	Incl.
Alternate Pump Location*	N/A	N/A	DRAIN KITS		
			Deluxe Cable Drain	Incl.	Incl.
HEATER			LIGHTS		
Heater Inline/Electric	\$395	Incl.	Mood Light	\$195	\$195
Hydro Clean Sanitation System	\$495	\$495	Chromatherapy	\$395	\$395
Hydrocleanse Pint bottle	\$19.95	\$19.95	PILLOW		
Aromatherapy System	\$195	\$195	Deluxe Oval	\$80	Incl.
Aromatherapy Fragrances 8oz (see pages 3-4)	\$16.95	\$16.95	STANDARD COLORS		
CONTROLS			White Bone Almond Biscuit	Incl.	Incl.
Air Switch on/off	Incl.	Incl.			
Air Switch w/ digital Temp Readout	N/A	N/A			

Tranquil 430

51" x 29" x 40"

Air Massage Series \$12,975

#TA 5030 /RH (right hand)
#TA 5030/LH (left hand)

Combination Series \$14,950

#TG 5030/RH (right hand)
#TG 5030/LH (left hand)

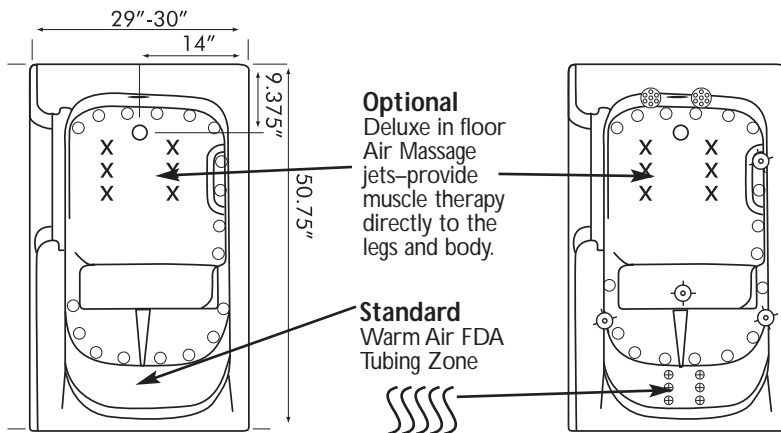

Equipment Legend

- X Optional deluxe in floor air massage jets
 - Turbo Air Jet
 - ⊕ Accu-Massage
 - Micro Flow or Optional Micromassage
 - Ultra Flow or Optional Ultra Massage
 - ⊙ Sole Soother
 - ⊕⊕ Neck Masseur Pillow
 - Pump
 - ▭ Alt. Pump
- Heated FDA Tubing Zone
- Pump Access (18"x18" required)
*Some pump locations & plumbing may extend beyond perimeter of bath

Electrical Specifications

	Air Massage	Combination
Pump Requirement		
115V 15AMP w/GFCI	1	1
115 V 20 AMP w/GFCI		1
Inline Heater Requirement		
115V 15AMP w/GFCI	optional	1
Gallons to Operate with 170lbs bather	76	

NOTE: Specifications are ± 1/4" and features are subject to change without notice
All final measurements should be taken from tub on site

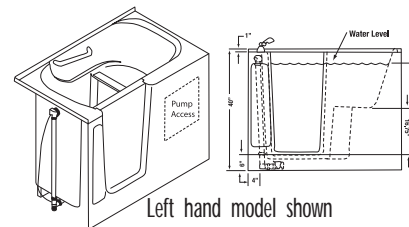

Features

	Aromassage Series	Combination Series		Aromassage Series	Combination Series
JETS			Deck Extension needed to convert to 60" framing pocket	\$460	\$460
Total number of jets	18	30	Faucet with Hand Shower	\$695	\$695
Accu-Massage	N/A	6	Thermostic Faucet, Valve, Hand Shower	\$1566	\$1566
Micro Flow	8	6	Wall Surround 3 Panel	\$1566	\$1566
Micro Massage (each)	\$40	\$40	Wall Surround 2 Panel	\$1225	\$1225
Sole Soother Seven (N/A in Metallic)	N/A	\$390	Curtain Rod w/ J hook and Ceiling Support	\$395	\$395
Back Masseur System	N/A	Incl.	Curtain Weighted White 78"x48"	\$200	\$200
Neck Jets	N/A	N/A	Aromatherapy Fragrance System	\$195	\$195
Metallic Trim Kit PC, PB, SN, ORB	\$250	\$600	Fragrance Refills	\$16.95	\$16.95
PUMPS			Hydrocleanse Whirlpool Sys Clnr	\$19.95	\$19.95
2.25 Hydro Power 1 speed	Incl.	N/A	GRAB BAR		
2.25 Hydro Power 3 speed	\$250	N/A	Bolt on PC	Incl.	Incl.
3.25 Hydro Power 3 speed	N/A	incl.	TILE FLANGE		
Alternate Pump Location*	N/A	N/A	2 Wall	Incl.	Incl.
HEATER			DRAIN KITS		
Heater Inline/Electric	\$395	Incl.	Deluxe Cable Drain	Incl.	Incl.
Hydro Clean Sanitation System	\$495	\$495	LIGHTS		
Hydrocleanse Pint bottle	\$19.95	\$19.95	Mood Light	\$195	\$195
Aromatherapy System	\$195	\$195	Chromatherapy	\$395	\$395
Aromatherapy Fragrances 8oz (see pages 3-4)	\$16.95	\$16.95	PILLOW		
CONTROLS			Deluxe Oval	\$80	Incl.
Air Switch on/off	Incl.	Incl.	STANDARD COLORS		
Air Switch w/ digital Temp Readout	N/A	N/A	White Bone Almond Biscuit	Incl.	Incl.
Electronic Variable Speed	Incl.	Incl.			