

Contempra COCG6032SKTF 60"x 32" x 20"

PRODUCT NUMBER: COCG6032SKTF-LH & COCG6032SKTF-RH 

COMBINATION GOLD SERIES

Hydro Massage
Your Health ... Our Passion

TECHNICAL SPECIFICATIONS	
Drain	End drain
Pump Location(s)	Std. = Standard / Alt LF/RF Optional
Bath Weight (empty)	165 lbs
Gallons to Operate	38-56
ELECTRICAL SPECIFICATIONS	
Motor/Pump	(2) 115v 20AMP GFCI Circuits
Inline Stainless Steel Heater	(1) 115v 20AMP GFCI Circuit

BATHERS: 1	
INSTALLATION	
	DECK (D)
	UNDER MOUNT (U)
•	ALCOVE (A)
	FREESTANDING (F)
	CLAWFOOT (L)
	PEDESTAL (P)

Jet & Control placement may vary





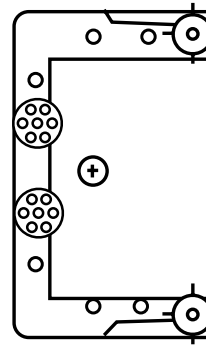

Integral Skirt for Zen Contempra



STANDARD FEATURES & ACCESSORIES for COMBINATION GOLD SERIES BATHS

JETS

- 30 Air & Water Massage Jets
- Back Massage System(s) (6 Jets)
- Sole Soother Jets 
- Accumassage Back & Neck Jets 
- Ultra Flow Jets 
- Classic Air Jets 

PUMPS

- 1- 3.25 Hydropower 3-speed Pump
- 1.25 Air Power Variable Speed, Pulse & Wave heated Air Pump
- Quiet Pad Anti-Vibration Mounted Pump

HEATERS

- Stainless Steel Electric Heater
- Warm Back Rest Tubing Zone

CONTROLS

- Air Switch On/Off Control(s) For Hydro Pump & Chromatherapy Lighting
- Electronic Variable Speed Air Massage Control
- Automatic Purge & Dry Cycle Control
- 3 Speed Massage: High, Medium or Low

PURITY

- HydroClean Water Purity System
- HydroCleanse

STANDARD ACCESSORIES

- Grab Bar(s) -2 on End Drain baths - White, Biscuit, Bone, Brushed Nickel, Polished Chrome
- Chromatherapy Lighting
- Deluxe Cable Drain - White, Biscuit, Bone, Brushed Nickel, Oil Rubbed Bronze, Polished Chrome
- Deluxe Cushion Pillow
- Integral Skirt with Magnetic Access Panel
- EZ Level Base
- FDA Recipe Non-Toxic Food & Beverage Grade Plumbing (primarily)
- 30 Point Quality Assurance Factory Test

REQUIREMENTS

- Pump Locations: Select 2
- Electrical: three 115v 20amp GFCI Circuits
- Drain and Grab Bars: Select Color / Finish
- Tub should not be supported by the lip in any way. Level tub & screw or glue adjustable legs to sub floor.**

CUT OUT DIMENSIONS:

- OVALS:** A template will be provided
- RECTANGLES:** Subtract 1" to 1.5" from length & width for hole cut out size

EZ CLEAN CAST ACRYLIC LIMITED LIFETIME WARRANTY 

OPTIONAL FEATURES & ACCESSORIES

(Please type in the box below)

- A** X **HTT® Leg Therapy Air Massage System** includes 10 Air Jets on the floor. Optional on Combo Plat and Combo Gold Series
- B** X **6 Jet HTT® Back Massage System:** N/A on Combo Series-Standard on Plat series
- C**  **Warm Back Tubing Zone**

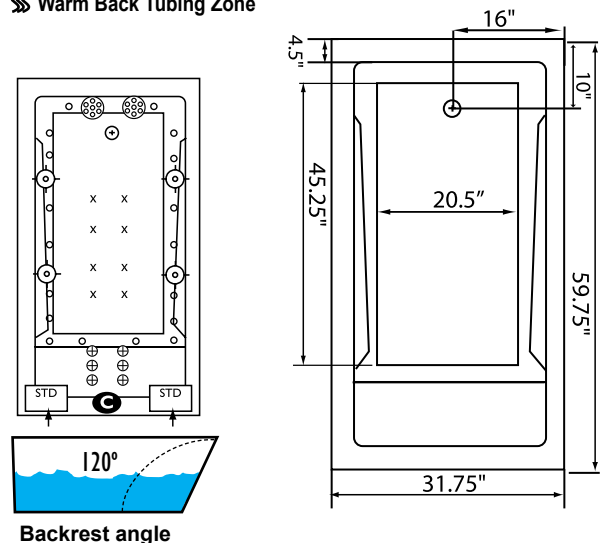
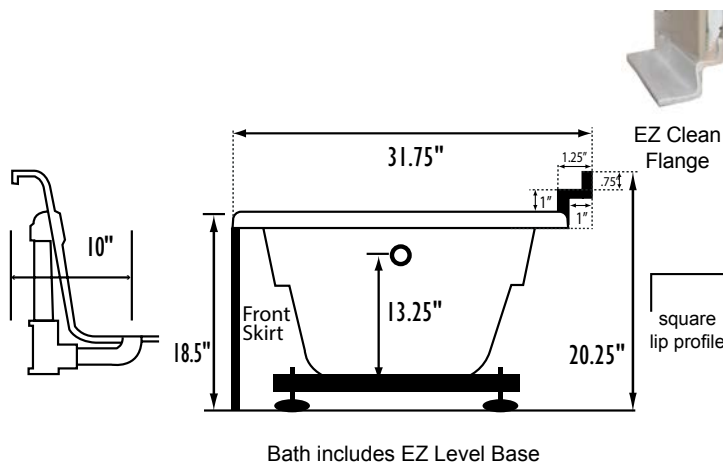

Some standard & most alternate pump locations may stickout past perimeter of the bath 1"-3". NOTE: Graphics may not be to scale. Specifications and features are subject to change without notice and are ± .25". All final measurements should be taken from tub on site. Access 18"x 18" or larger is required for each pump. Consult your contractor for installation requirements.